

PENELOPE

design Sebastiano Tosi 2017

Collezione di lampade in filo di metallo con LED integrati.

Materiali: metallo

Finiture: Bianco opaco, nero opaco, bronzo chiaro, ottone.

Fonte luminosa: LED doppi integrati

Luce diretta: 17 W 110/ 230v 1350lm 3000° K

Luce indiretta: 4,5 W110/ 230v 450lm 3000° K

Metal wire frame lamp collection with LED integrated

Materials: metal

Finishes: integrated matte white, matte black, light bronze, brass

Light: double LED integrated

Direct light: 17 W 110/ 230v 1350lm 3000° K

Indirect light: 4,5W 110/230v 450lm 3000° K

C1

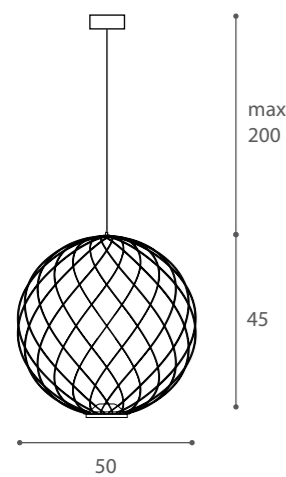

F1

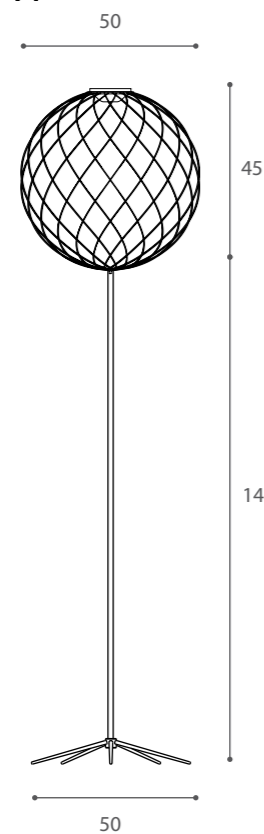



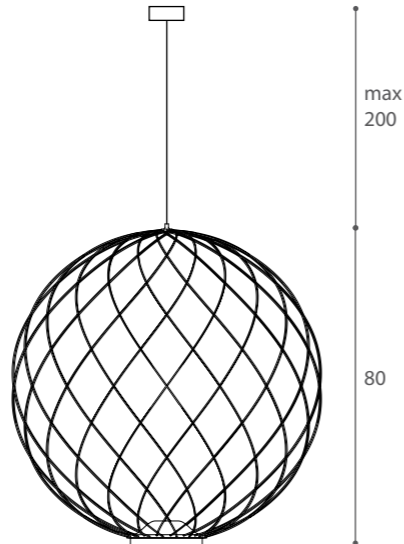

C2

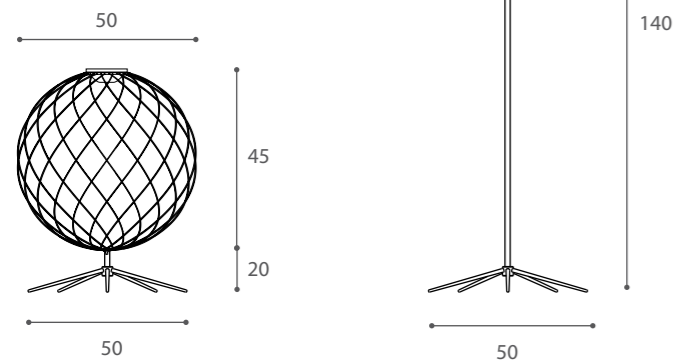

T1



C1/C2 luce indiretta: LED 4,5 W110/ 230v 450 Lm 3000K°  
luce diretta: LED 17W 110/230V 1350lm 3000°K 

F1/T1 luce indiretta: LED 4,5 W110/ 230v 450 Lm 3000K°   Dimmer included
luce diretta: LED 17W 110/230V 1350lm 3000°K 